

**MK-070C-HP**

**High Performance 7 Inch  
Capacitive Touch Display**

August 2019  
Revision D

**DATA SHEET**

**Amulet**



## Introduction

The MK-070C-HP is the first family member in Amulet's High Performance Line of display products. The new, re-architected 7" Capacitive Display Module incorporates Amulets new high performance Graphics Display Card. The Display Card is based around a 540Mhz ARM A5 processor architecture and is the next generation of HMI cards. The MK-070C-HP has 4Gb of DDR2 RAM, 4GB eMMC Flash module, and SD card socket with support over 64GB. The module has an 800x480 WVGA TFT LCD with a projected capacitive touch panel.

The High Performance Graphics Display Card integrates the Amulet Graphical OS (GEM OS) with the high performance, cost-sensitive, processor architecture of the ARM Cortex series. Capable of executing 840 DMIPS aided by an integrated LCD controller with graphics accelerator and floating point unit (FPU) for faster data processing, the Graphics Display Card is the perfect solution for any integrated, embedded, HMI solution.

The MK-070C-HP, 7" Projected Capacitive Display Module is the perfect solution for any high performance graphical user experience.

## Features

### Module

- 536Mhz ARM A5 Processor
- 4Gb of DDR RAM at 166Mhz
- 4GB eMMC Flash and  $\mu$ SD Card Socket

- Operating Temperature: -20°C to 70°C

## Display

- 7" WVGA (16:9 diagonal)
- Luminance: 500 nit (cd/m<sup>2</sup>)
- Contrast Ratio: 400:1
- Viewing Angle: 60° Top-Bottom, 70° Left-Right

## Touch Panel

- Projected Capacitive Touch
- Operates with gloved hands and rejects liquids
- Gestures: Tap, Flick, Scroll, finger swipe
- 1.8mm protective, integrated cover glass and touch sensor

## Communication Interfaces

- 1 UART-TTL socket for the common 802.15.4 XBee wireless footprint.
- 1x SPI with 3 Chip Selects
- 1x I<sup>2</sup>C
- RS-485
- RS-232
- 8x GPIO
- 2x PWM
- USB 2.0 Device Interface

## Power

- Multiple options for input power
  - 12V DC
  - 24V AC
  - 5V USB power
- RTC with battery backup

## Board Component Descriptions

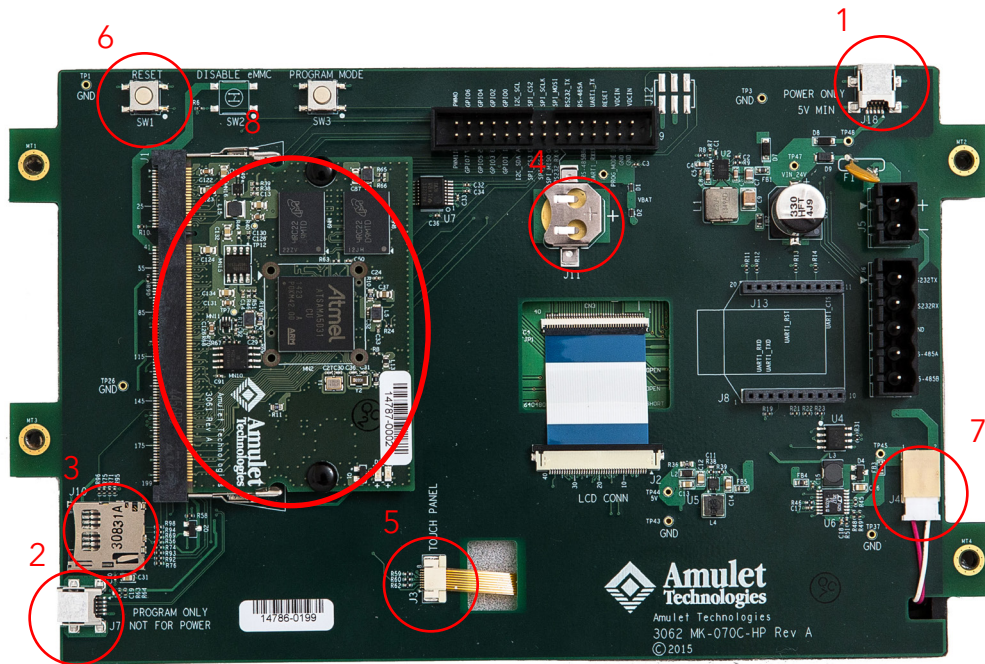

1. Mini-USB input power supply: This port designated J18 on the PCB is just one of many methods to power the display module. The power supply must be  $5V \pm 5\%$ , supplying at least 1A.

2. Mini-USB device programming port: When connected to the PC, the device will be recognized as a USB Mass Storage Device. Within GEMstudio Pro, Amulet's integrated design environment, the compiled projects will get stored in the onboard eMMC.

3.  $\mu$ SD card slot: The external SD card has two functions. Display projects can be updated using the SD card. During boot, the project on the SD card can be read and written onto the eMMC directly. The SD Card can be used for data storage with the read/write function accessed through read/written to from GEMscript.

Note: the  $\mu$ SD card is not supplied with the module.

4. Battery Backup: the function of the battery backup is to keep the RTC (Real-Time Clock) operating even with the loss of module power. The battery used is the CR1225 3V watch battery. Note: the battery is not supplied with the module.

5. FPC (Flat Panel Cable) connector for touch panel signals.

6. Reset switch.

7. Power cable for the LCD backlight.

8. Graphics Display Card

## Pin Configuration

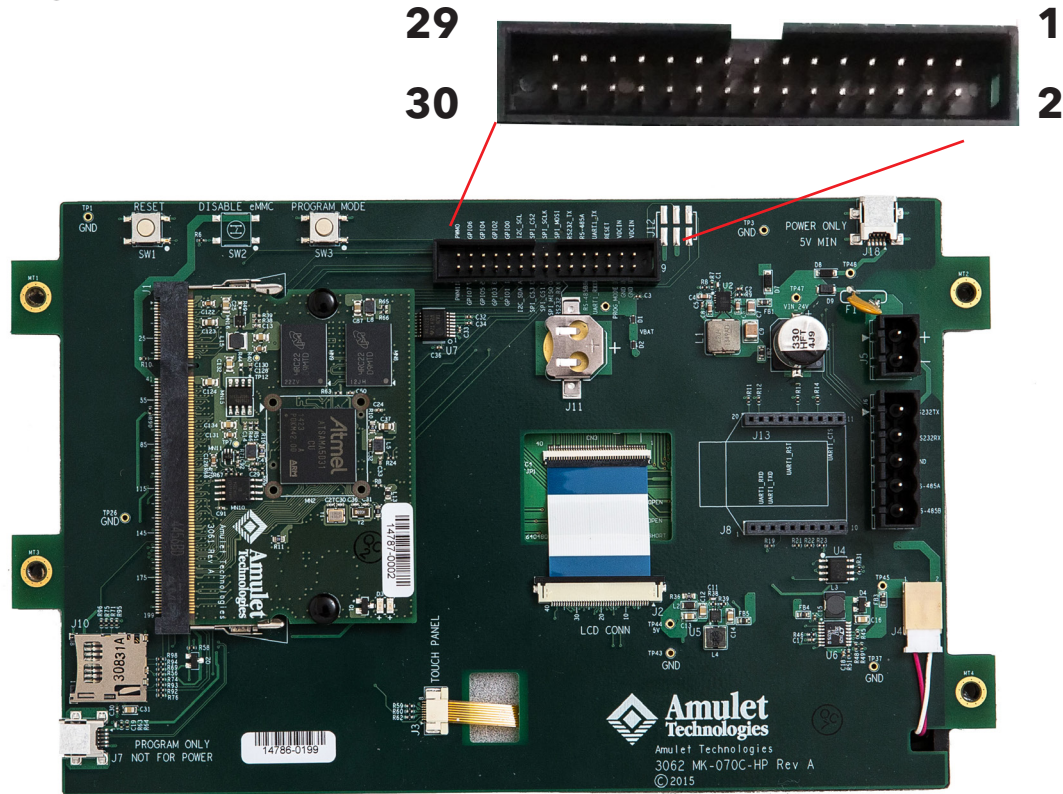

**30 Pin I/O Socket - J9**

Details	Description	Pins Number	Description	Details
Supply Voltage In	8-24 VDC IN	1 2	GND	Common Ground
Supply Voltage In	8-24 VDC IN	3 4	GND	Common Ground
SOM Reset, Active Low	RESET	5 6	PROG_MODE	Program Mode, Active Low
UART1 Transmit Port	UART1_TX	7 8	UART1_RX	UART1 Receive Port
Inverting Differential Line	RS-485A	9 10	RS-485B	Non-Inverting Differential Line
RS-232 Transmit Port	RS-232 TX	11 12	RS-232 RX	RS-232 Receive Port
SPI - Master Out, Slave In	SPI_MOSI	13 14	SPI_MISO	SPI - Master Input, Slave Output
SPI - Serial Clock	SPI_SCLK	15 16	SPI_CS1	SPI - Chip Select 1
SPI - Chip Select 2	SPI_CS2	17 18	SPI_CS3	SPI - Chip Select 3
I2C - Serial Clock Line	I2C_SCL	19 20	I2C_SDA	I2C - Serial Data Line
General Purpose Input/Output 0	GPIO 0	21 22	GPIO 1	General Purpose Input/Output 1
General Purpose Input/Output 2	GPIO 2	23 24	GPIO 3	General Purpose Input/Output 3
General Purpose Input/Output 4	GPIO 4	25 26	GPIO 5	General Purpose Input/Output 5

General Purpose Input/Output 6	GPIO 6	27	28	GPIO 7	General Purpose Input/Output 7
Pulse Width Modulation Port 0	PWM 0	29	30	PWM 1	Pulse Width Modulation Port 1

The part number for the J9 header used on the board is 302-S301 from On Shore Technology. The mating connector has the part number 101-306.

The 30-pin J9 socket duplicates many of the same signals that are available from other places on the board.

Pin 7 and Pin 8, the UART1 transmit and receive signals respectively, also exist on the J8 header. The J8 and J13, parallel headers are compatible with many Zigbee, Bluetooth, 802.11 modules which are already on the market.

The RS485 differential signals, Pin 9 and Pin 10, are the same signals as the RS485 signals on the J6 communication header.

The RS232 transmit and receive signals, on Pin 11 and Pin 12, respectively also exist on the J6 communication header.

Pin 1 and Pin 2 can be used to power the display module using 12VDC  $\pm$  30% input. The MK-070C-HP has been designed for ultimate flexibility in mind, and can be powered by many different voltage sources. Alternatively the module can be powered with 24VAC  $\pm$  15% using the J5 power connector. The module can also be powered with 5V  $\pm$  5% through the J18 USB power port.

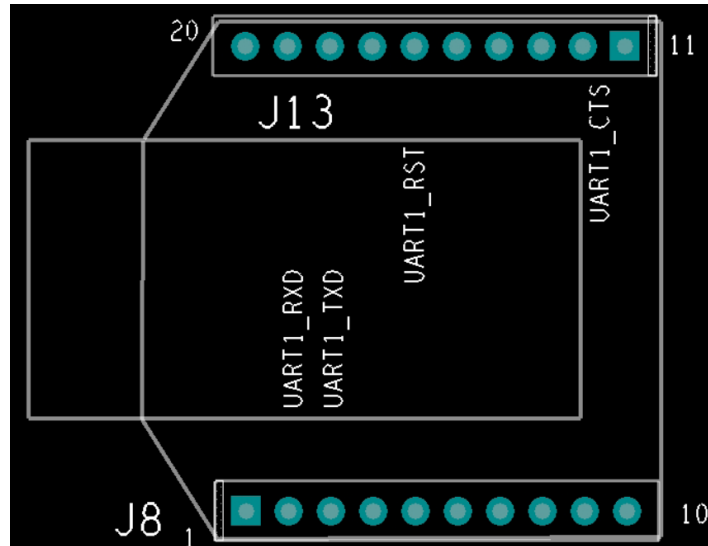

20 Pin I/O Sockets - J8/J13					
Details	Description	Pin Number		Description	Details
		J8	J13		
3.3 VDC	3.3 VDC output	1	20	RFU	10k Pull-down
Pin 11 PE25	UART1_RX	2	19	RFU	10k Pull-down
Pin 13 PE26	UART1_TX	3	18	NC	NC
100k Pull-down	RFU	4	17	NC	NC
100k pull-up, GPIO7	GPIO 7	5	16	UART1_RTS	UART1 Request To Send
100k Pull-down	RFU	6	15	RFU	Pin 9 PE24
100k Pull-down	RFU	7	14	NC	NC
2.2k Pull-up	RFU	8	13	RFU	100k Pull-down
NC	NC	9	12	UART1_CTS	UART1 - Clear To Send
GND	GND	10	11	NC	NC

Socket J8 and J13 are compatible with multiple wireless modules on the market based on the common 802.15.4 XBee footprint. For example, the Roving Networks Zigbee, Bluetooth, and WiFi modules.

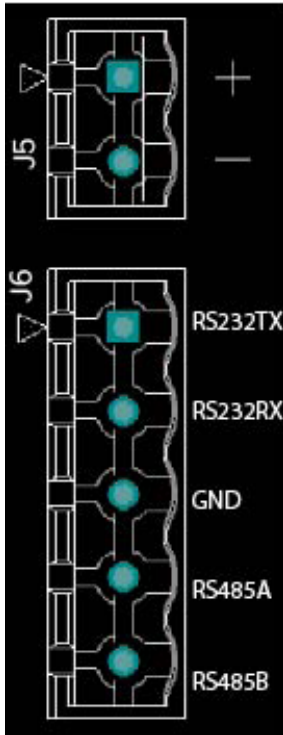

Power Input Header - J5		
Pin Number	Description	Details
1	AC/DC Power Input	24 VAC input or 12 VDC
2	Common Ground	AC Common Ground

Note: Header J5 is reverse polarity protected

Communication Header - J6		
Pin Number	Description	Details
1	RS232TX	RS232 Transmit
2	RS232RX	RS232 Receive
3	GND	Common Ground
4	RS-485A	Inverting Differential Line
5	RS485B	Inverting Differential Line

The headers J5 and J6 used on the board are manufactured by Molex. The part number for J5 is 39531-1002 and the J6 part number is 39531-1005. This type of connector mates with the Molex 39530 family of connectors.





Mechanical Specification

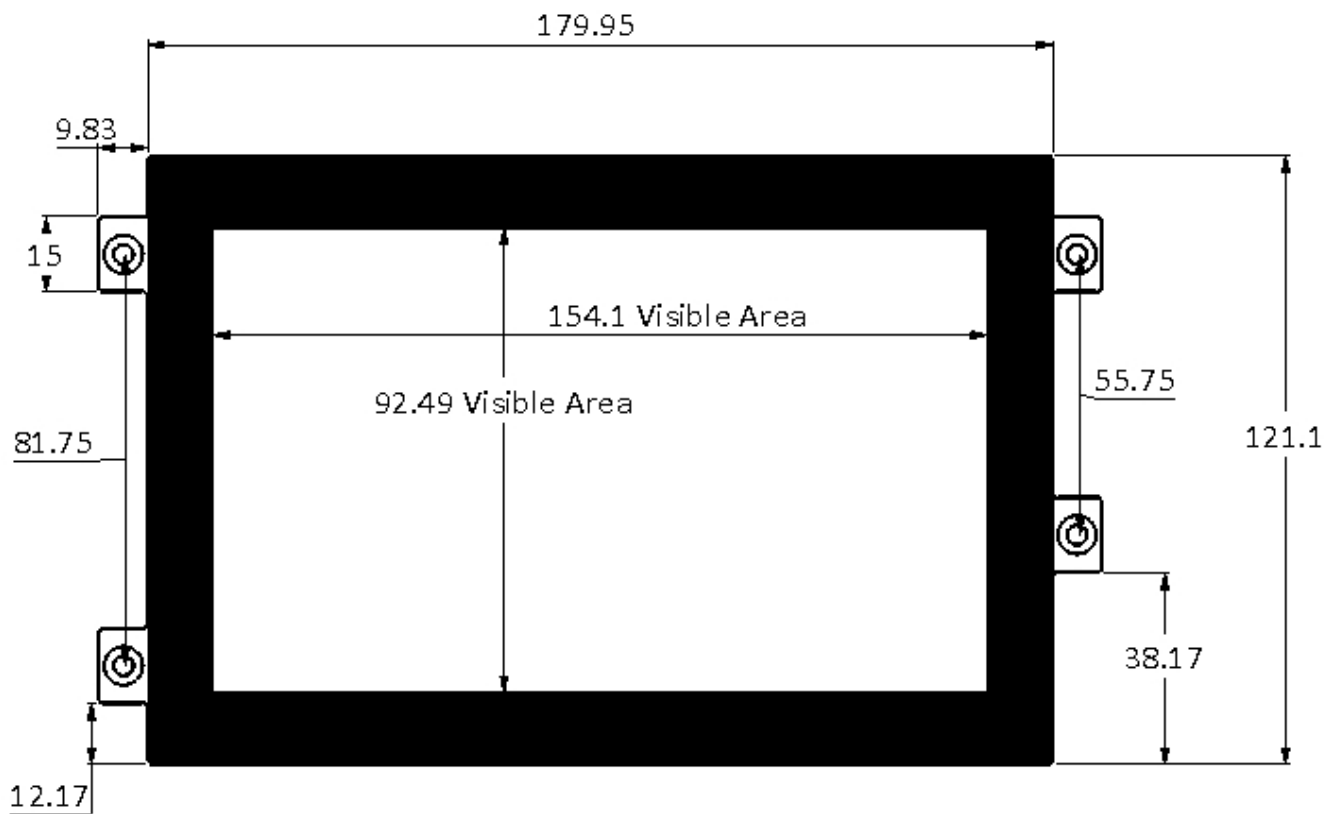
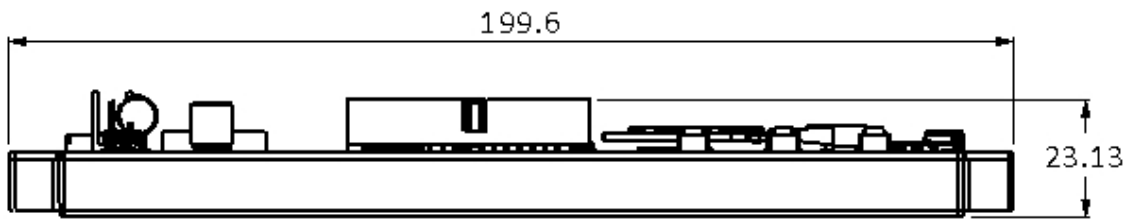

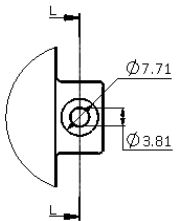

DETAIL J  
SCALE 2 : 1

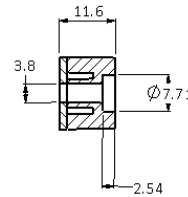

SECTION L-L  
SCALE 2 : 1

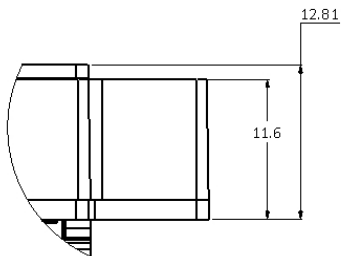
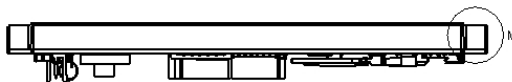

DETAIL M  
SCALE 5 : 1

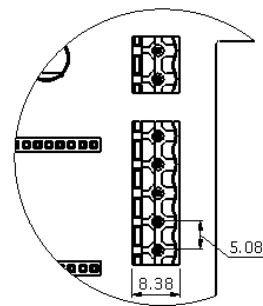
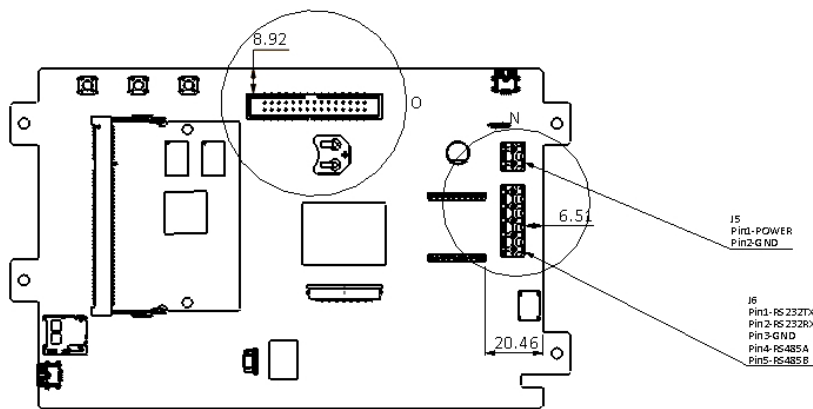

DETAIL N  
SCALE 2 : 1

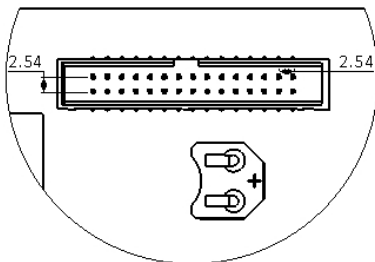

## Recommended Operating Conditions

Parameter	Conditions	Min	Typ	Max	Units
DC Supply Voltage	Stable external supply required	7.4	12	24.6	Vdc
AC Supply Voltage	Stable external supply required	20.4	24	27.6	Vac
USB port Supply Voltage	Stable external supply required	4.75	5	5.25	Vdc

## Environmental Specification

Parameter	Min	Typ	Max	Units
Storage Temp	-30		80	°C
Operating Temp	-20		70	°C

## Revision History

Date	Revision	Notes
13 July 2015	A	Publication
14 October 2016	B	Corrected J9 socket power description and DC supply voltage operating conditions
13 January 2017	C	Corrected 4GB to 4Gb for DRAM



## Contact Us:

# You have Embedded GUI Questions. We have Answers.

Amulet Technologies Headquarters  
1475 S. Bascom Ave., Suite 111  
Campbell, CA 95008  
USA

Phone: (408) 374-4956  
Fax: (408) 374-4941  
Email: [info@amulettechnologies.com](mailto:info@amulettechnologies.com)

Sales and Customer Support:  
Phone: (888) 374-8688  
Sales Email: [sales@amulettechnologies.com](mailto:sales@amulettechnologies.com)  
Support Email: [support@amulettechnologies.com](mailto:support@amulettechnologies.com)  
Developer Support: [devSupport@amulettechnologies.com](mailto:devSupport@amulettechnologies.com)

**Disclaimer:** The information in this document is provided in connection with Amulet Technologies, LLC (Amulet) products. No license, express or implied, to any intellectual property right is granted by this document or in connection with the sale of Amulet products. EXCEPT AS SET FORTH IN AMULET'S TERMS AND CONDITIONS OF SALE WHERE AMULET IS THE SELLER, AMULET ASSUMES NO LIABILITY WHATSOEVER AND DISCLAIMS ANY EXPRESS, IMPLIED OR STATUTORY WARRANTY RELATING TO ITS PRODUCTS INCLUDING, BUT NOT LIMITED TO, THE IMPLIED WARRANTY OF MERCHANTABILITY, FITNESS FOR A PARTICULAR PURPOSE, OR NON-INFRINGEMENT. IN NO EVENT SHALL AMULET BE LIABLE FOR ANY DIRECT, INDIRECT, CONSEQUENTIAL, PUNITIVE, SPECIAL OR INCIDENTAL DAMAGES (INCLUDING, WITHOUT LIMITATION, DAMAGES FOR LOSS AND PROFITS, BUSINESS INTERRUPTION, OR LOSS OF INFORMATION) ARISING OUT OF THE USE OR INABILITY TO USE THIS DOCUMENT, EVEN IF AMULET HAS BEEN ADVISED OF THE POSSIBILITY OF SUCH DAMAGES. Amulet makes no representations or warranties with respect to the accuracy or completeness of the contents of this document and reserves the right to make changes to specifications and product descriptions at any time without notice. Amulet does not make any commitment to update the information contained herein. Unless specifically provided otherwise, Amulet products are not approved for use in automotive applications, medical applications (including, but not limited to, life support systems and other medical equipment), avionics, nuclear applications, or other high-risk applications (e.g., applications that, if they fail, can be reasonably expected to result in significant personal injury or death).